

RPS International Inc.

780-668-3395/780-962-1443 Fax

Joeonto@telusplanet.net

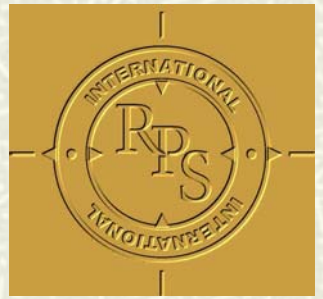

TPS Tactical Precision Systems Inc.



2008 - CHRISTMAS SPECIAL WHILE STOCK LASTS

– TPS 1” Scope rings on sale – ’06 pricing and no
gst – while supplies last. Get your order in before
Dec. 10, 2008 - MERRY CHRISTMAS

TPS offers 3 styles of scope rings.

HRT series....



....TRS and W series

MAY 2006 - Prices &
Specs. subject to change

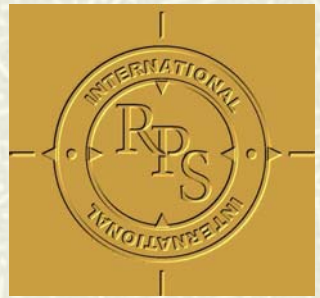

TSR Scope Rings.

TSR™ RINGS

A .020 of an Inch gap to ensure adequate adjustment for variety of scope manufactures.

The TPS™ Rings utilize a unique design which allows the user to fully tighten the left side of the ring, uniquely allowing the user to precisely rotate the scope to adjust the scope reticle for proper position, then tighten the right side of the rings, guaranteeing that the scope will not rotate within the rings, which is virtually impossible in any other design.

Both Base and Cap of each scope ring is within .0002 of an Inch cylindrical roundness, guaranteeing as much as 98% scope tube to ring contact, compared to 40% on normal rings. The necessity of serializing or lapping scope rings are now obsolete.

TPS™ tactical rings are manufactured from a solid billet of 7075-T651 aluminum. The scope rings and components are manufactured using state-of-the-art Computer Numerically Controlled (CNC) machines. Each and every part is processed and inspected to ISO 9002 quality standards throughout the manufacturing process.

The cross bolt and tightening nut are from alloy steel, finished with black oxide to Mil-C-13924 standards. The ring body and cap are finished in a matte black hard anodized to Type III per Mil-A-8625 standards. The ring caps are securely clamped to the ring base with (4) four Torx® screws.

**NO LAPPING
NO SERIALIZING
NEEDED!!**

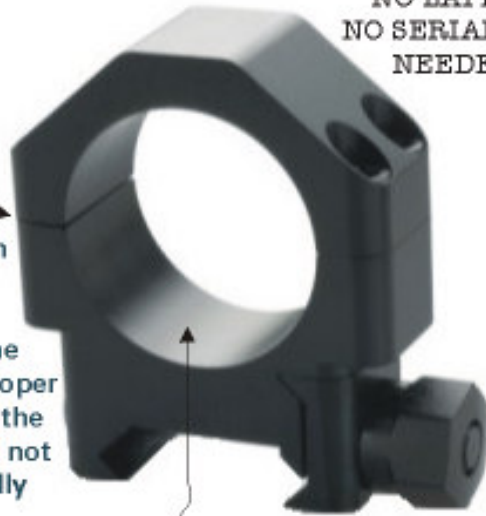

MATERIAL PROPERTIES:

7075-T6511 Aluminum (Heat Treated)

Tensile Strength: 99 Ksi

Yield Strength: 93 Ksi

Brinell Hardness: 158

(K=1,000 pounds per square inch)

The TPS™ Rings are compatible with Mil-STD 1913 (Picatinny) bases.

RPS International Inc.

780-668-3395/780-962-1443 Fax

Joepto@telusplanet.net

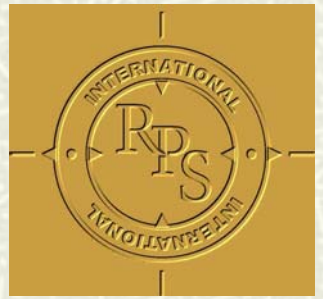

TSR Scope Rings

TPS TSR Scope Rings are.....

Fully compatible with the following scope base manufactures:

Tactical Precision Systems, Inc. (XP Tactical Bases)

Badger Ordnance (Maximized Scope Bases)

PGWDTI (PGW Defence Technologies, Inc.)

Near Manufacturing, Inc.

NightForce Scope Bases

GG&G Scope Bases

IOR HD Tactical Scope Bases

A.R.M.S. Mounts

RPS International Inc.

780-668-3395/780-962-1443 Fax

Joepono@telusplanet.net

TSR™ RINGS
W-Series

**WEAVER® COMPATIBLE
TACTICAL SCOPE RINGS**

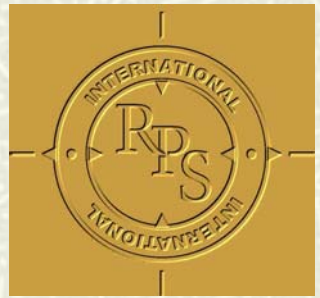

The **TSR™ "W" Series Rings** utilize the same unique design as our standard TSR™ rings, which allows the user to fully tighten the left side of the ring, uniquely allowing the user to precisely rotate the scope to adjust the scope reticle for proper position, then tighten the right side of the rings, guaranteeing that the scope will not rotate within the rings, which is virtually impossible in any other design.

Both base and cap of each scope ring is within 2/10,000 of an inch cylindrical roundness, guaranteeing as much as 98% scope tube to ring contact, compared to 40% on normal rings. The necessity of serializing and lapping scope rings are now obsolete.



The TSR™ tactical scope rings are manufactured from a solid billet. Available in 7075-T651 aluminum, 1215 alloy steel or 416 Stainless Steel. The rings and components are manufactured using state-of-the-art Computer Numerically Controlled (CNC) machines. Each and every part is processed and inspected to ISO 9002 quality standards throughout the manufacturing process.

The cross-bolt and tightening nut are from alloy steel for the aluminum and steel rings, finished with black oxide to Mil-C-13924 standards. The cross-bolt and hex nut are 304 stainless in stainless models. The ring body and cap are finished in a matte black hard anodize to Type III per Mil-A-8625 standards in the aluminum rings. In the steel rings, they are finished with black oxide to Mil-C-13924 standards. The stainless steel rings are bead blasted to a matte finish. The ring caps are securely fastened to the ring base with (4) four Torx® screws.

MAY 2006 - Prices &
Specs. subject to change

RPS International Inc.

780-668-3395/780-962-1443 Fax

Joeonto@telusplanet.net



TSR™ RINGS
W-Series
WEAVER® COMPATIBLE
TACTICAL SCOPE RINGS

TPS W Scope Rings are.....

Fully compatible with the following scope base manufactures:

Weaver® and Weaver-Style Scope Bases

Tactical Precision Systems, Inc. (XP Tactical Bases)

Badger Ordnance (Maximized Scope Bases)

Farrell (Farrell Industries, Inc.) Scope Bases

PGWDTI (PGW Defence Technologies, Inc.)

Near Manufacturing, Inc.

NightForce Scope Bases

GG&G Scope Bases

IOR HD Tactical Scope Bases

A.R.M.S. Mounts

RPS International Inc.

780-668-3395/780-962-1443 Fax

Joeonto@telusplanet.net



HRT Scope Rings

The **HRT™ "H" Series Rings** combine our ever-popular ZERO-CANT™ design along with eye-pleasing contours to enhance the beauty of your favorite rifle.

The HRT™ rings have all the quality and craftsmanship that you have come to expect, with a more slim-line design tailored toward those seeking to have a less tactical appearance about their rings.

The rings are fully compatible with Weaver® bases and Mil-STD 1913 (Picatinny bases.)



Both base and cap of each scope ring is within 2/10,000 of an inch cylindrical roundness, guaranteeing as much as 98% scope tube to ring contact, compared to 40% on normal rings. The necessity of serializing and lapping scope rings are now obsolete.

The HRT™ scope rings are manufactured from a solid billet of 1215 Alloy Steel or 7075-T651 aluminum alloy, depending upon your preference. The rings and components are manufactured using state-of-the-art Computer Numerically Controlled (CNC) machines. Each and every part is processed and inspected to ISO 9002 quality standards throughout the manufacturing process.

The square cross-slot recoil-lugs are 4140 Alloy Steel. In the alloy steel configuration, the ring body and cap are finished in a matte black with a black oxide finish to Mil-C-13924 standards. The 7075 Aluminum alloy rings are hard anodize to Type III per Mil-A-8625 standards. The ring caps are securely fastened to the ring base with (4) four Torx® screws.

MAY 2006 - Prices &
Specs. subject to change

RPS International Inc.

780-668-3395/780-962-1443 Fax

Joeonto@telusplanet.net

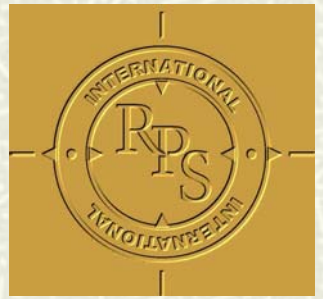

HRT Scope Rings

TPS HRT Scope Rings are.....

Fully compatible with the following scope base manufactures:

Weaver® and Weaver-Style Scope Bases

Tactical Precision Systems, Inc. (XP Tactical Bases)

Badger Ordnance (Maximized Scope Bases)

Farrell (Farrell Industries, Inc.) Scope Bases

PGWDTI (PGW Defence Technologies, Inc.)

Near Manufacturing, Inc.

NightForce Scope Bases

GG&G Scope Bases

IOR HD Tactical Scope Bases

A.R.M.S. Mounts

PRICE LIST.....

RPS International Inc.

780-668-3395/780-962-1443 Fax

Joepono@telusplanet.net

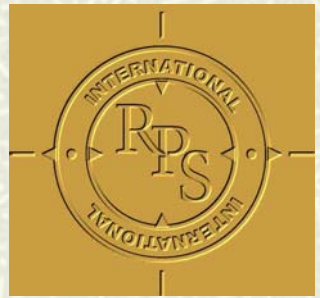

TPS Tactical Precision Systems Inc.

TSR & W Scope Rings – 1”

Item	Product Description	Mfg Code	Price
	1" TSR Scope Rings - STEEL		
1a	1" TSR Scope Rings - Steel - LOW	30500	\$ 92
1b	1" TSR Scope Rings - Steel - MED	30501	\$ 92
1c	1" TSR Scope Rings - Steel - HIGH	30502	\$ 94
	1" TSR Scope Rings - Alum. 7075 (Aircraft grade)		
2a	1" TSR Scope Rings - Al 7075 - LOW	30520	\$ 85
2b	1" TSR Scope Rings - Al 7075 - MED	30521	\$ 85
2c	1" TSR Scope Rings - Al 7075 - HIGH	30522	\$ 88
	1" TSR Scope Rings - Stainless Steel		
3a	1" TSR Scope Rings - Stainless Steel - LOW	30503	\$ 111
3b	1" TSR Scope Rings - Stainless Steel - MED	30504	\$ 111
3c	1" TSR Scope Rings - Stainless Steel - HIGH	30505	\$ 114
	1" "W" - (Weaver/Farrell/Burris)Scope Rings - STEEL		
4a	1" "W" Scope Rings - Steel - LOW	30600	\$ 95
4b	1" "W" Scope Rings - Steel - MED	30601	\$ 95
4c	1" "W" Scope Rings - Steel - HIGH	30602	\$ 98
	1" "W" - (Weaver/Farrell/Burris) Scope Rings - AL7075		
5a	1" "W" Scope Rings - Al 7075 - LOW	30620	\$ 89
5b	1" "W" Scope Rings - Al 7075 - MED	30621	\$ 89
5c	1" "W" Scope Rings - Al 7075 - HIGH	30622	\$ 92
	1" "W" - (Weaver etc..) Scope Rings - Stainless Steel		
6a	1" "W" Scope Rings - Stainless Steel - LOW	30603	\$ 115
6b	1" "W" Scope Rings - Stainless Steel - MED	30604	\$ 115
6c	1" "W" Scope Rings - Stainless Steel - HIGH	30605	\$ 118

MAY 2006 - Prices &
Specs. subject to change

RPS International Inc.

780-668-3395/780-962-1443 Fax

Joepono@telusplanet.net

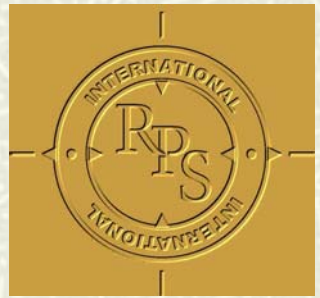

TPS Tactical Precision Systems Inc.

HRT Scope Rings – 1”

Item	Product Description	Mfg Code	Price
	1" HRT Scope Rings - STEEL		
7a	1" HRT Scope Rings - Steel - LOW	40500	\$ 87
7b	1" HRT Scope Rings - Steel - MED	40501	\$ 87
7c	1" HRT Scope Rings - Steel - HIGH	40502	\$ 92
	1" HRT Scope Rings - Alum. 7075 (Aircraft grade)		
8a	1" HRT Scope Rings - Al 7075 - LOW	40520	\$ 78
8b	1" HRT Scope Rings - Al 7075 - MED	40521	\$ 78
8c	1" HRT Scope Rings - Al 7075 - HIGH	40522	\$ 81
	1" HRT Scope Rings - Stainless Steel		
9a	1" HRT Scope Rings - Stainless Steel - LOW	40503	\$ 115
9b	1" HRT Scope Rings - Stainless Steel - MED	40504	\$ 115
9c	1" HRT Scope Rings - Stainless Steel - HIGH	40505	\$ 118